

 *Safety on board...*

CLASSIC HATCH	3
ULTRA SLIM HATCH	4
SLIDING HATCH	5
FLUSH HATCH	6
CONCEALED HINGED FLUSH HATCH	7
WATERTIGHT FLUSH HATCH	8
WATERTIGHT RAISED COAMING HATCH	9
BOLTON PORTHOLES	10
CLAMPING PORTHOLES	11
AREA1 PORTHOLES	12
AREA1 STAINLESS STEEL PORTHOLES	13
BOAT WINDOWS	14-15
WEATHERTIGHT ALUMINIUM DOORS	16
PANTOGRAPH DOORS	17
WATERTIGHT ALUMINIUM DOORS	18
WATERTIGHT STEEL DOORS	19
ENTERANCE & SALOON DOORS	20
TYPE APPROVALS & CERTIFICATES	21-32

Bofor founded in 1986, with production of marine windows, portholes and hatches. Today, it is the well known manufacturer and exporter of watertight/weather tight doors, watertight/weather tight flush deck hatches, electrical/manual operated SS316 sliding doors, marine windows, hatches and portholes. With years of experience and strict policies on quality has gained recognition not only at home but also all over the world. Exporting the %50 of the manufactured products to Germany, Holland, Greece, France, Finland, Croatia, Romania, Ukraine, Russia, Norway, UAE, Australia, Singapoure, Japan, Egypt, Israel, Yemen etc.

Today, company has a wide range of marine deck closures, from smaller size boats to over 60 meters mega yachts, including Oyster Yachts of England, KaiserWerft, Numarine etc.

All our partners are very welcome to the world of quality, service, alternatives and problem solving of marine deck closures in our Bofor family.

 *“Your Safety on board”*

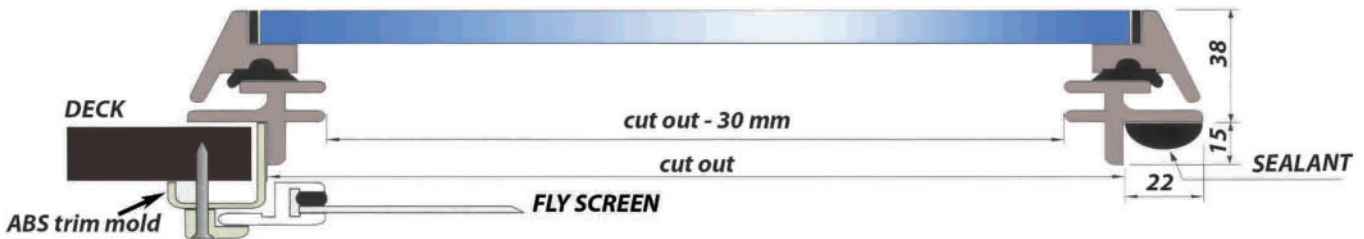

BOFOR CLASSIC HATCH, CE approved and certified at design category A on area II
Simple conventional design for quick and safe fixing.

This heavy-duty hatch is made of top quality aluminium alloy extrusion, hand-polished and deep anodized for maximum corrosion resistance. A thick acrylic with UV addition is fixed on the self-supporting frame carefully by quality sealant to give 100 % waterproofing.

SQUARE, RECTANGULAR and TRAPEZOID shapes and many sizes to choose from.

Can be locked from inside by slide switch on the handle.

External handles enable hatch to open from outside if not locked.

Friction hinge to open in any position Adjustable by M8 inbus bolt & nut in the hinge.

Joints are water-proof by neoprene.

Beige ABS trim molding to suit any hull thickness.

CUSTOMIZED HATCHES are manufactured, with cut out radius $r = 40, 65, 75$ and 100 mm (without ABS finishing frame)

MODEL	Overall size Ax Bmm	Cut out C x D mm	Cut out r radius mm	Weight kgs	Acrylic thick mm
HTC-20	240 X 240	202 X 202	40	1.5	10
HTC-22	240 X 385	202 X 347	40	2.0	10
HTC-26	300 X 300	260 X 260	40	2.0	10
HTC-30	360 X 490	320 X 450	40	5.0	10
HTC-40	460 X 460	420 X 420	40	5.6	10
HTC-41	410 X 540	370 X 500	40	6.0	10
HTC-50	545 X 545	505 X 505	40	6.8	10
HTC-60	660 X 660	620 X 620	40	10.4	12
HTC-70	740 X 740	700 X 700	40	12.5	12

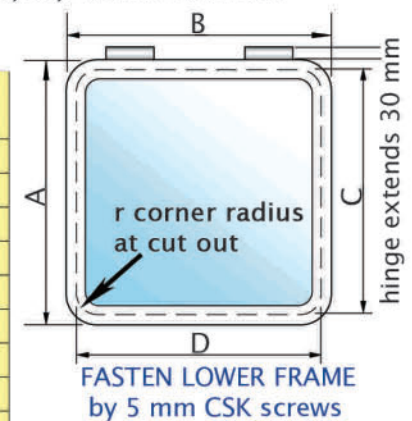

BOFOR MARINE PRODUCTS: HATCHES, PORTHOLES, WINDOWS and DOORS...

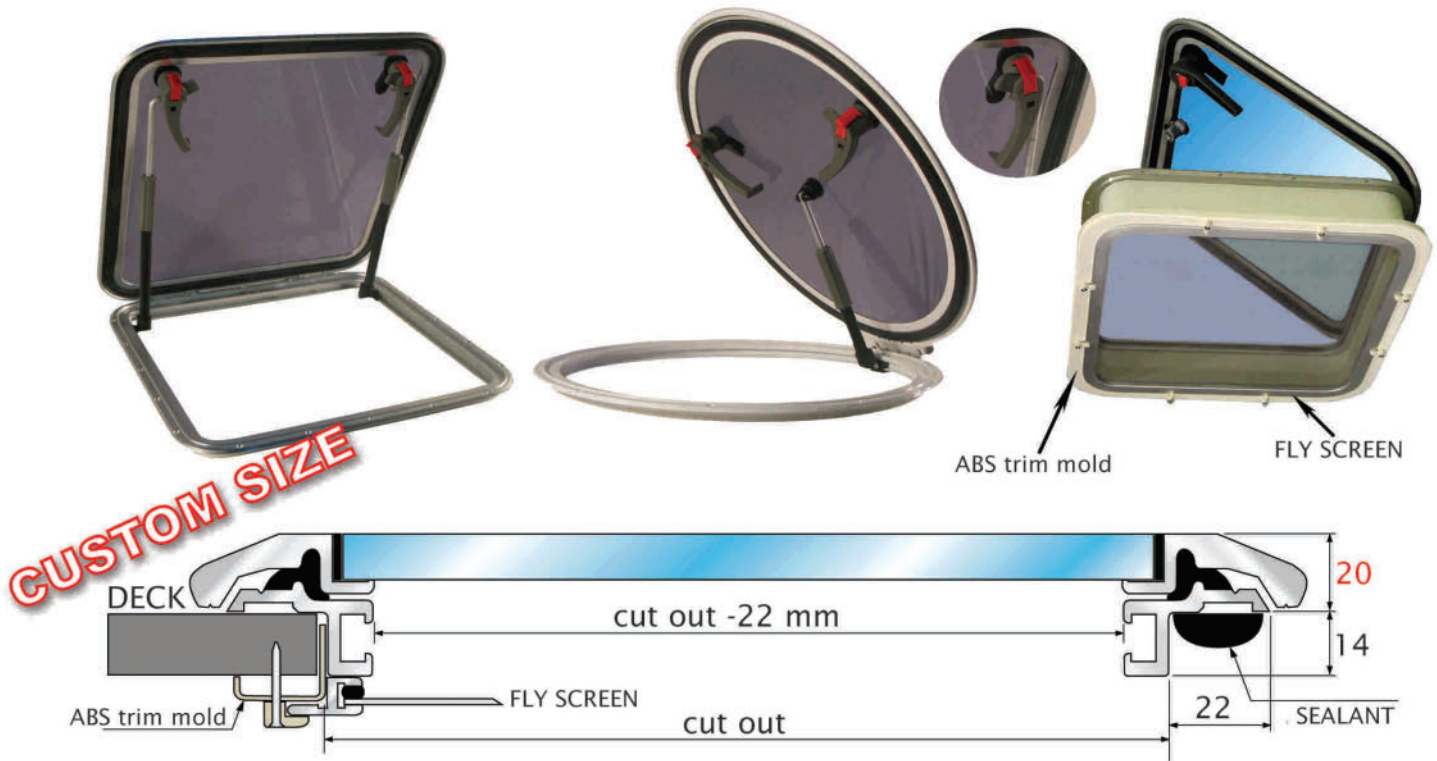

CUSTOM SIZE

BOFOR ULTRA SLIM HATCH, is only 20 mm high from deck,

CE approved and certified at design category A on area II,

Designed for quick and safe fixing, made of top quality aluminium alloy extrusion, hand-treated and deep anodized for maximum corrosion resistance. A thick acrylic with UV addition is carefully fixed on the self-supporting frame by quality sealant to give %100 waterproofing.

SQUARE, RECTANGULAR, ROUND and TRAPEZOID shapes and many sizes to choose from. Easy to open and close by quick acting handles. Can be locked from inside by button switch on the handle. External handles enable hatch to open from outside if not locked.

Upper frame designed to open in any position. Joints are water-proof by neoprene.

CODE	Overall size Ax B mm	Cut out Cx D mm	Radius Rmm	Weight kgs	Acrylic thickness
HSLM-1	270 x 270	205 x 205	40	1.1	10
HSLM-2	240 x 295	175 x 230	40	1.2	10
HSLM-3	240 x 485	175 x 420	40	2.0	10
HSLM-4	325 x 325	260 x 260	40	1.6	10
HSLM-5	270 x 410	205 x 345	40	2.1	10
HSLM-6	385 x 515	320 x 450	40	3.5	10
HSLM-7	485 x 485	420 x 420	40	4.2	10
HSLM-8	465 x 565	400 x 500	40	4.8	10
HSLM-9	565 x 565	500 x 500	40	5.3	10
HSLM-045	Ø 480	Ø 415	208	3.4	10
HSLM-055	Ø 580	Ø 515	258	5.0	10
HSLM-TRAP A x B x H	A=685 x B=540 x H=555	a=620xb=475 x h=490	40	5.6	10

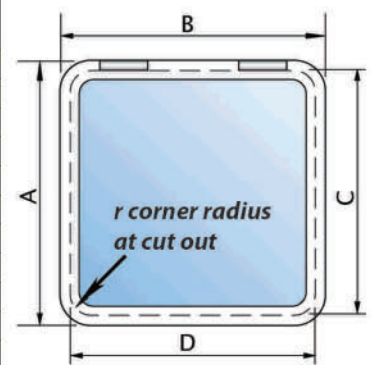

FASTEN LOWER FRAME by 5mm CSK screws

A,a= hinged side, B,b = opposite hinged side, H,h = perpendicular

BOFOR MARINE PRODUCTS:HATCHES,PORTHOLES,WINDOWS and DOORS

CUSTOM SIZES

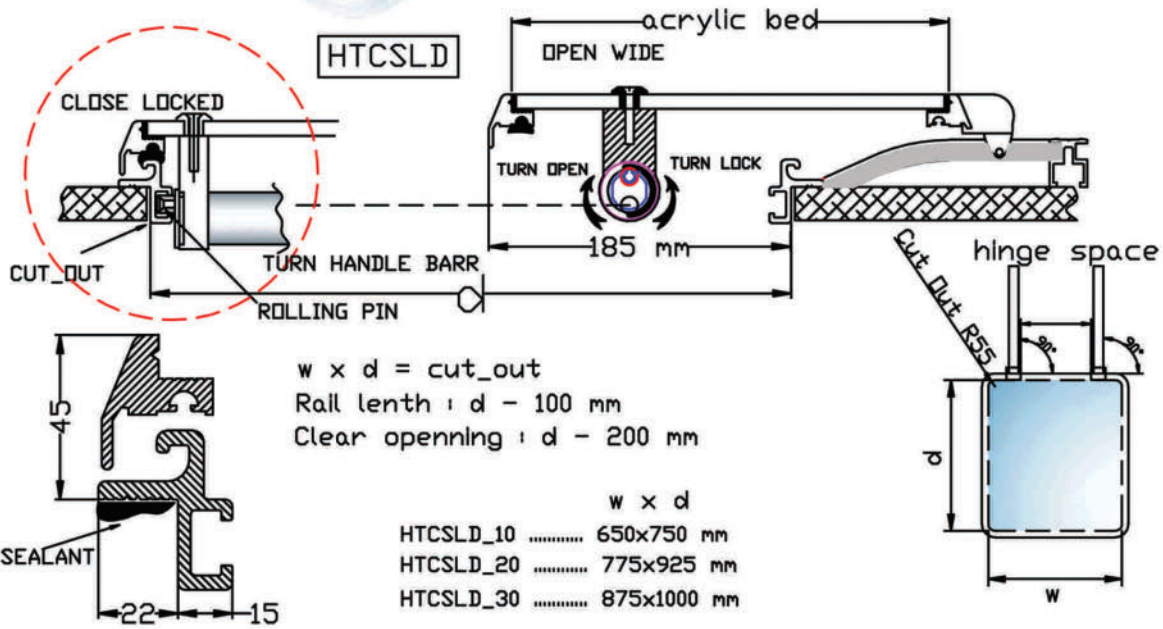

SHOULD BE FITTED TO A FLAT SURFACE WITH A MAXIMUM TOLERANCE OF +/- 1 mm

Anodized aluminum body

Smooth operating - easy to use

Lexan safety glass

Neoprene sealing gasket

Full insulation for all weather conditions

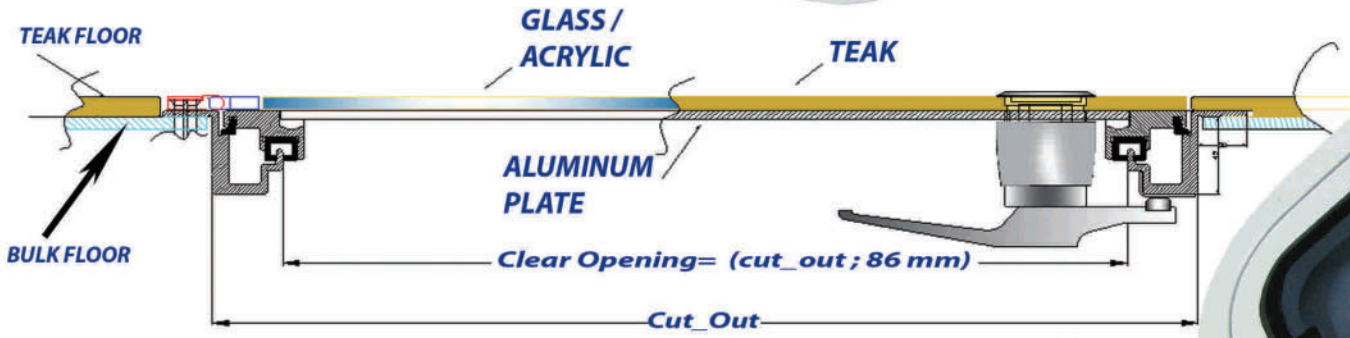
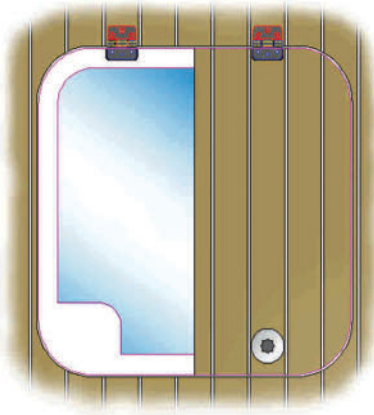

CUSTOM SIZE

- Aluminum Frames
- Glass / Acrylic Lens
- Welded Aluminum Plate Ready For Teak Coverings
- Dual Sealing Gasket
- Height Adjustable Handles And SS316 Hinges
- Mega Yacht Quality Paint
- Custom Made



Aluminum Frames

Glass / Acrylic Lens

Custom Sizes

Welded Aluminum Plate ready for teak covering

Adjustable Handles

Concealed SS Hinges

Mega yacht quality paint



Aluminum or steel body

Stainless steel handles and dog assembly

Stainless steel hinged

Neoprene sealing gasket

Stainless steel mechanism

Full insulation for weather conditions

Mega yacht quality paint

WATERTIGHT MANHOLES WITH COAMING



CUSTOM SIZE

Aluminum body

Stainless steel mechanism

Stainless steel hinged

Neoprene sealing gasket

Stainless steel handles and dog assembly

Watertight

Mega yacht quality paint

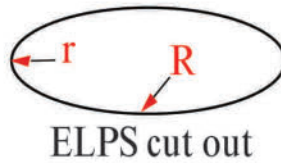
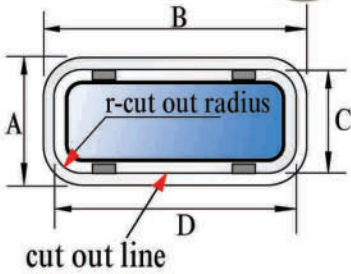

ABS trim mould

BOFOR BOLTON PORTHOLE is a simple conventional design for quick and safe mounting. This range is mostly suitable for wooden boats with thicker hull depths. ABS trim mould is adjusted in depth by fixing the ABS frame from the inside of the boat through the cut out area, and trimming in depth the extended excess from the outer surface. The main frame is then fixed from the outside, through the ABS frame. The wide flange and outside fixing holes on the port hole compensates for rougher surfaces and less careful workmanship.

Opening Porthole	FORM	Overall size Ax B mm	Cut out C x D mm	Cut out radius r, r x R mm	Weight kgs	Glass thickness	ABS depth mm
LMZ - 26	○	∅ 260	∅ 225	∅ 113	1,1	6	70
LMZ - 17x40	◻	175 x 400	132 x 365	65	1,2	6	70
LMZ - 20x40	◻	200 x 400	162 x 365	84	1,3	6	110
LMZ - 26x50	◻	260 x 500	225 x 465	115	2,5	6	140
LMZ - 24x40	◻	240 x 400	205 x 365	65	1,4	6	110
LMZ - 24x50	◻	240 x 500	205 x 465	65	2,0	6	110
LMZ - 30x50	◻	300 x 500	265 x 465	65	2,6	6	110
LMZ - 35x60	◻	350 x 600	315 x 565	65	3,7	6	110
ELPS - 26x50	◻	260 x 500	225 x 670	65 x 810	2,0	6	110

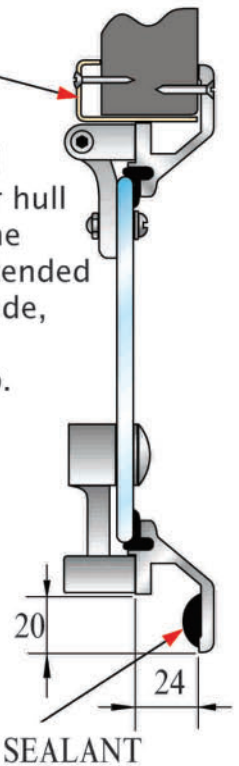

BOFOR MARINE PRODUCTS: HATCHES, PORTHOLE, WINDOWS and DOORS...

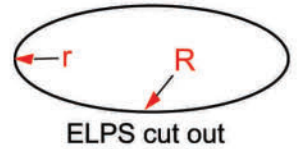
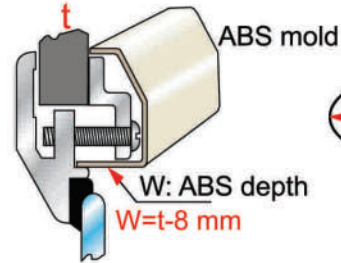
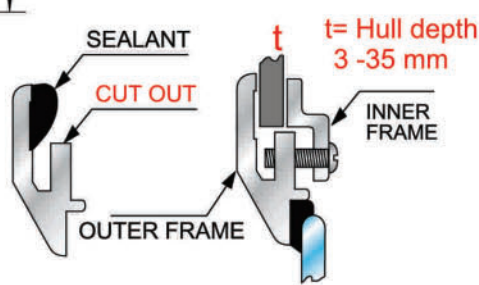
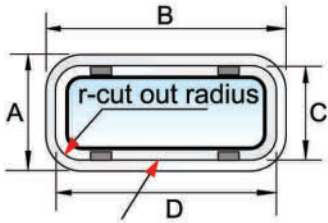

Opening Porthole	Fixed Porthole	Overall size Ax B mm	Cut out C x D mm	Cutout radius r, r x R mm	Weight kgs	Securit glass thickness mm
RND20	NA	∅200	∅175	88	1.1	6
RND25	NA	∅250	∅225	113	1.3	6
OVL1	OVLDL 1	200 x 375	171 x 347	86	1.7	6
OVL2	OVLDL 2	200 x 400	171 x 375	86	1.9	6
OVL3	OVLDL 3	200 x 433	171 x 405	86	2.2	6
OVL4	OVLDL 4	250 x 500	225 x 475	113	2.8	6
ELPS1	NA	200 x 400	175 x 380	55 x 370	1.7	6
ELPS 2	NA	200 x 450	175 x 430	55 x 470	2.4	6
ELPS 3	NA	250 x 500	225 x 480	55 x 395	2.4	6
RECO	RDLO	184 x 330	156 x 303	55	1.6	6
REC1	RDL1	184 x 433	156 x 405	55	2.0	6
REC 2	RDL2	200 x 375	171 x 347	55	1.7	6
REC 20x40	RDL 20x40	200 x 400	175 x 375	55	1.9	6
REC 25X50	RDL 25x50	250 x 500	225 x 475	55	3.0	6
REC 3	RDL 3	200 x 457	171 x 429	55	2.4	6
REC 4	RDL 4	200 x 655	171 x 627	55	2.7	6
REC 5	RDL 5	272 x 457	244 x 429	55	2.7	6
REC 6	RDL 6	245 x 405	215 x 375	55	2.4	6
REC4L	RDL 4L	200 x 716	175 x 688	55	2.8	6
REC4R	RDL 4R	200 x 716	175 x 688	55	2.8	6

Deck thickness (mm)	3 to 6	6 to 10	10 to 14	14 to 18	18 to 22	22 to 27	28 to 32	32 to 36
Fastening	M5 x12	M5 x 16	M5 x 20	M5 x 25	M5 x 30	M5 x 35	M5 x 40	M5 x 45

BOFOR MARINE PRODUCTS: HATCHES, PORTHOLES, WINDOWS and DOORS...



Rectangular, oval, elliptic and round sizes to choose from

SS 316 opening frame secures the 10 mm thick lens

Adjustable SS 316 friction hinges and locking handles

Highly anodized aluminum main body clamping frame

Hull thickness 4 - 20 mm, no need for plastic inner frames

Lens clear of obstructions inside and out for 100 % clear view

Easy to install with sealant or closed cell tapes

Neoprene sealing gasket

Opening and fixed models

Model	Form	Overall size	Cut out	Radius Cut out	Dept
RND-25B	○	∅ 250	∅ 225	113 mm.	4-20 mm.
OVL-2B	◻	200 x 400	171 x 375	86 mm.	4-20 mm.
OVL-4B	◻	250 x 500	225 x 475	113 mm.	4-20 mm.
REC-20X40b	◻	200 x 400	175 x 375	55 mm.	4-20 mm.
REC-6B	◻	245 x 405	215 x 375	55 mm.	4-20 mm.
ELPS-2B	◻	200 x 450	225 x 430	55 x 470 mm.	4-20 mm.

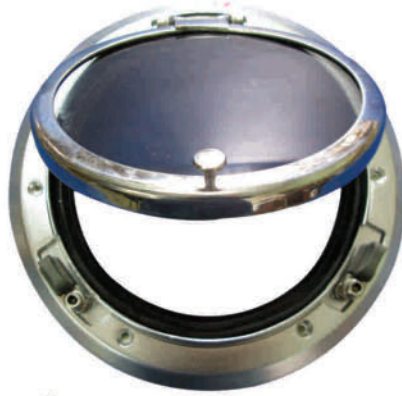

Eliptic and round sizes to choose from

SS316 main body

Adjustable SS316 opening frame secures the 10 mm thick lens

Adjustable SS316 friction hinges and locking handles

Hull thickness 4-20 mm, no need for plastic inner frames

Easy to install with sealant inside and out for 100 % clear view

Neoprene sealing gasket

Opening and fixed models

CUSTOM MADE for any geometry and size



CLAMPING SLIM GROUP

- FIXED SINGLE GLASS
- SLIDING
- HALF DROP
- THERMAL DOUBLE GLASS
- FULL HINGED opening
- HALF HINGED opening

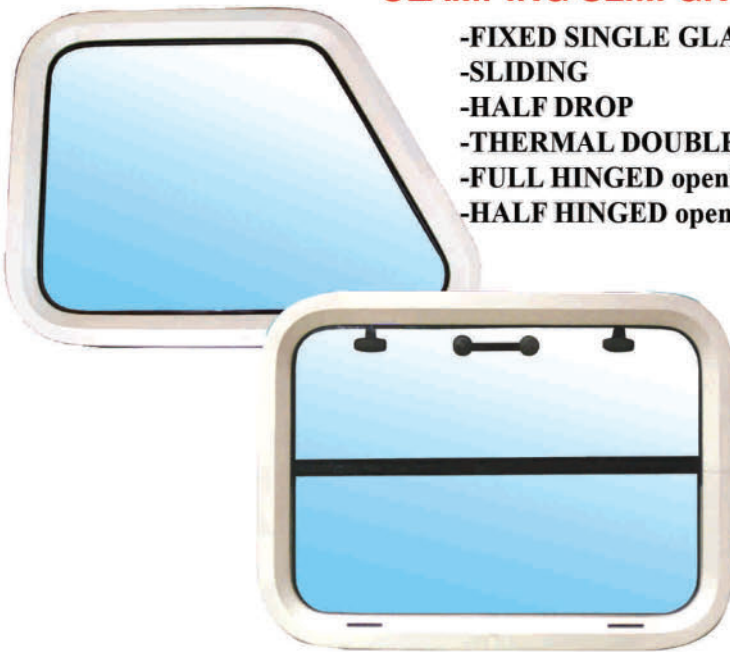

GLASS: TOUGHENED, secure
COLOUR: NEUTRAL or TINTED
GREY, GREEN, BRONZE
PROFILE: NATURAL or BLACK
ANODIZED and POWERCOATED

CLAMPING HEAVY DUTY GROUP

- FIXED SINGLE GLASS
- SLIDING
- HALF DROP
- THERMAL DOUBLE GLASS



STANDARD GROUP

- FIXED SINGLE GLASS
- SLIDING
- HALF DROP

BOFOR MARINE PRODUCTS: HATCHES, PORTHOLES, WINDOWS and DOORS...

CLAMPING SLIM WINDOW

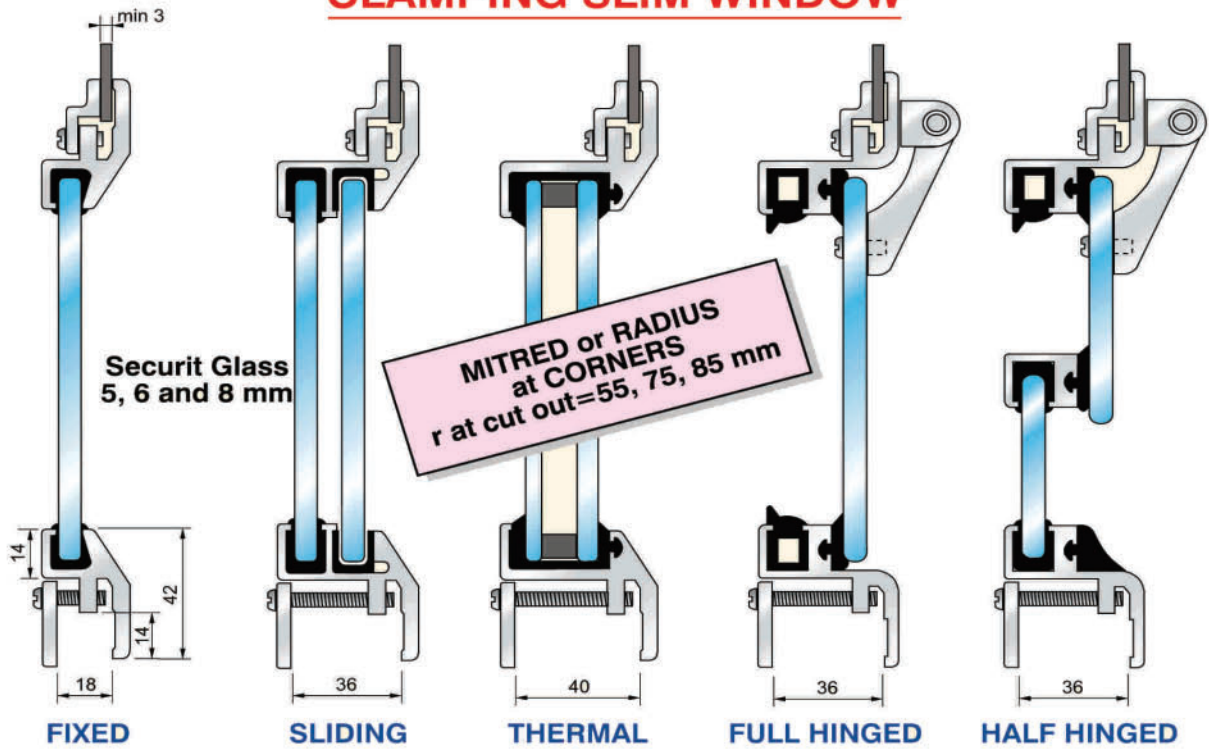

CLAMPING HEAVY WINDOW

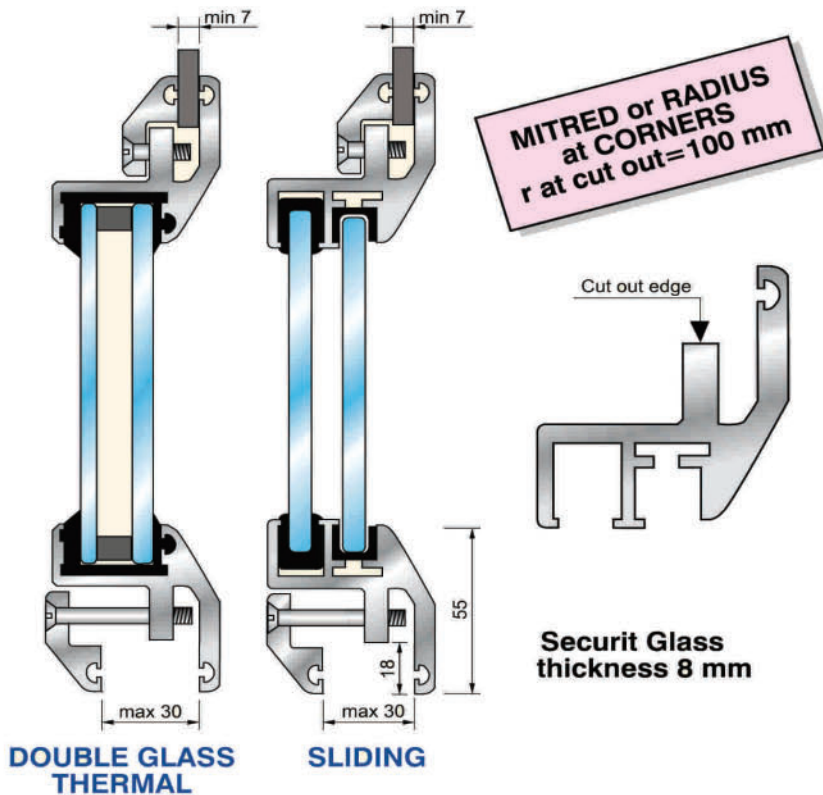

STANDARD PROFILE

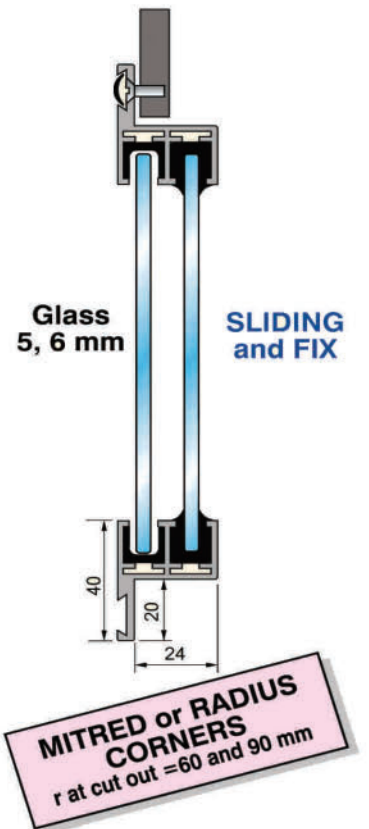

CUSTOM SIZE



Aluminum body

Stainless steel hinges

Laminated safety glass

Neoprene sealing gasket

Full insulation for weather conditions

Mega yacht quality paint



WEATHERTIGHT LIGHT ALUMINIUM DOORS

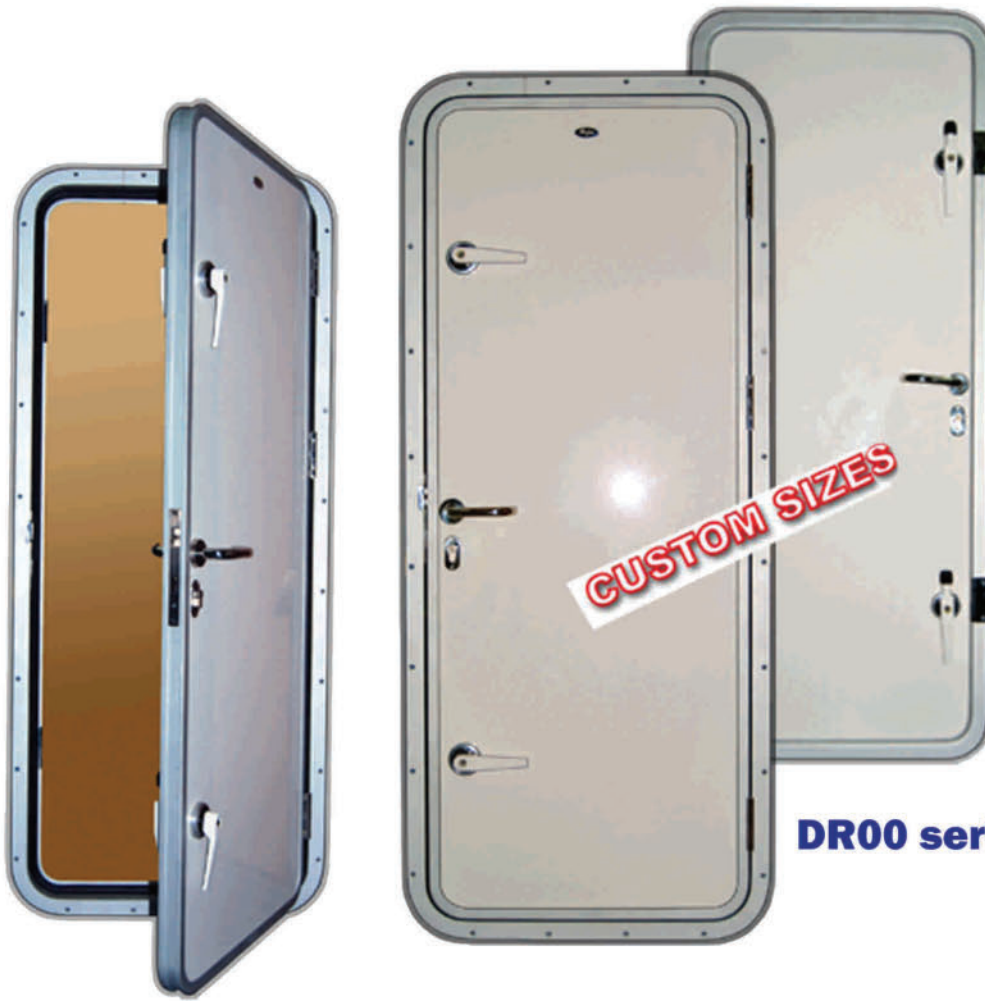

DR00 series

- extruded aluminum main and door frames
- interior / exterior aluminum plates
- full insulation
- optional: glass in frame, yacht finish paint

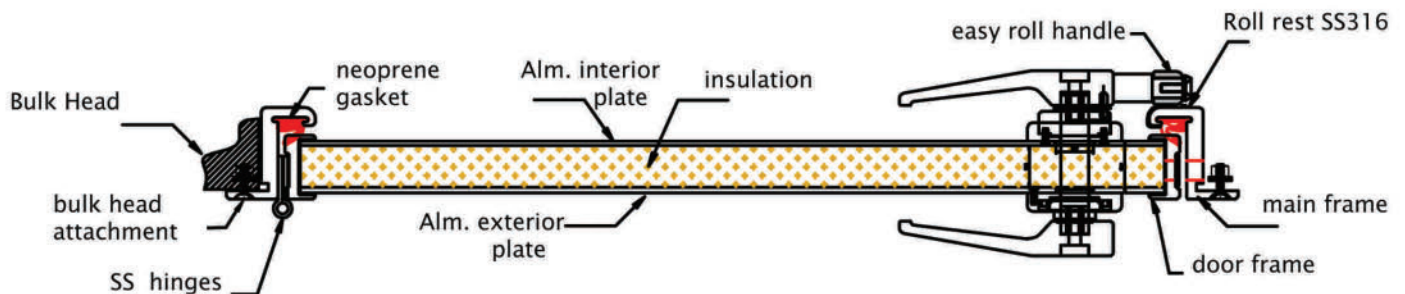
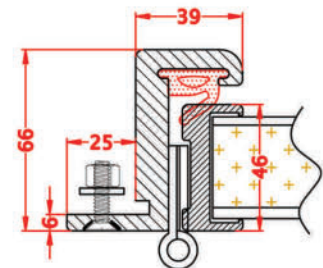



Concealed single handle operated multi dogs

Custom mode for any surface geometry

Adjustable decorative pantograph hinge

Neoprene sealing gasket

Stainless steel handles and dog assembly

Full insulation for weather conditions

Mega yacht quality paint

WATERTIGHT DOOR (Concealed handle)



TYPE APPROVED

CUSTOM SIZE

Aluminum body

Stainless steel handles and dog assembly

Aluminum hinged

Neoprene sealing gasket

Stainless steel mechanism

Full insulation for weather conditions

Mega yacht quality paint



CUSTOM SIZE

Steel Flush Body Frame

Stainless steel handle and dog assembly

Central locking dogs

Fully insulated by rock wool

Mega yacht quality paint

TYPE APPROVED

Steel body and frame (welded or bolted)

Hight adjustable SS316 hinge set

Easy roll handle set

Lub nipple on hinges and handles

Optional: Interior plate and insulation

Optional: Yacht finish paint

DRST03 series

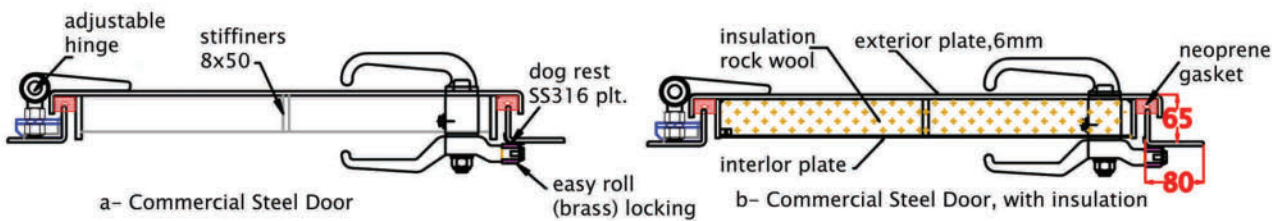



Stainles Steel

Full automatic control (or manual)

Laminated safety glass

Speed end power control

Safety precaution



CERTIFICATE

Registration Number : KorQ-084453

MSA Certification Co., Ltd. hereby certifies that the company

BOFOR DENIZCILIK SAN. VE TIC. LTD. STI.

IMES SANAYI SITESI C BLOK 308. SOK. NO:18
YUKARI DUDULLU-UMRANIYE 34775 ISTANBUL / TURKEY

For the scope of

**Manufacture and Sales of Marine Products for Ships
and Floating Structures**

Has established and applies a

Quality Management System

And an audit performed by MSA has verified that this management system
fulfils the requirements of the following standard:

ISO 9001: 2000

DIN EN ISO 9001: 2000

Certificate Issue Date : 16 December 2008 ~ Certificate Expiry Date : 15 December 2009

Initial Certification Date 16 December 2008

MSA Certification Date 16 December 2008

Certification Period 3 Years

Scheme Manager

MSA Certification Co., Ltd.

website: <http://www.msa-cert.com>

e-mail: msa@msa-cert.com



TGA-ZM-02-06-00

☐ This certificate is the property of MSA Certification Co., Ltd. and shall be returned upon request by MSA Certification Co., Ltd. FMP26/03(Rev.2)



CERTIFICATO DI OMOLOGAZIONE DI TIPO
TYPE APPROVAL CERTIFICATE
N. DIP070808XT

Si certifica che il seguente prodotto soddisfa le prescrizioni delle norme RINA per l'omologazione di tipo.
This is to certify that the product identified below is in compliance with the applicable requirements of the RINA type approval system.

Descrizione <i>Description</i>	Porta stagna <i>Watertight door</i>
Tipo <i>Type</i>	STEEL DOOR
Fabbricante	BOFOR DENIZCILIK SANAYI VE TICARET LTD.STI.
Luogo di produzione <i>Manufacturer</i>	IMES SANAYI SITESI, C BLOK, 308 SOKAK, NO.18 Y.DUDULLU, UMRANIYE, ISTANBUL
Norme di riferimento <i>Place of manufacture</i>	TURKEY
Norme di riferimento <i>Reference standards</i>	RINA Rules



Rilasciato a Genova il 2 Ottobre 2009. Questo
Certificato è valido fino al 22 Aprile 2012.
*Issued in Genoa on October 2, 2009. - This Certificate is valid
until April 22, 2012*

LUIGI FUDCO
RINA

Questo Certificato e' composto di 1 pagina e di 1 allegato.
This certificate consists of this page and 1 enclosure.

RINA Società per azioni
Via Corsica, 12 - 16128 Genova
Tel +39 010 53851
Fax +39 010 5351000



CERTIFICATO DI OMOLOGAZIONE DI TIPO

TYPE APPROVAL CERTIFICATE

N. DIP089108XT

Si certifica che il seguente prodotto soddisfa le prescrizioni delle norme RINA per l'omologazione di tipo.
This is to certify that the product identified below is in compliance with the applicable requirements of the RINA type approval system.

Descrizione <i>Description</i>	Porta stagna <i>Watertight door</i>
Tipo <i>Type</i>	ALUMINIUM DOOR
Fabbricante <i>Manufacturer</i>	BOFOR DENIZCILIK SANAYI VE TICARET LTD.STI.
Luogo di produzione <i>Place of manufacture</i>	IMES SANAYI SITESI, C BLOK, 308 SOKAK, NO.18 Y.DUDULLU, UMRANIYE, ISTANBUL
Norme di riferimento <i>Reference standards</i>	TURKEY RINA Rules

Rilasciato a Genova il 2 Ottobre 2009. Questo
Certificato è valido fino al 22 Aprile 2012
*Issued in Genoa on October 2, 2009. This Certificate is valid
until April 22, 2012*



LUIGI FUOCO
Luigi Fuoco
RINA

Questo Certificato e' composto di 1 pagina e di 1 allegato
This certificate consists of this page and 1 enclosure

RINA Società per azioni
Via Corsica, 12 - 16128 Genova
Tel +39 010 53851
Fax +39 010 5351000



TÜRK LOYDU

İKTİSADİ İŞLETMESİ

TYPE APPROVAL CERTIFICATE

Certificate No: TO.DEB.09-2343

This Certificate consist of 2 Pages

This is to certify that the

WATERTIGHT ALUMINIUM FLUSH HATCH
with type designations

FLSHTCWT 56, FLSHTCWT 60, FLSHCWT 65

Manufactured by

BOFOR DENİZCİLİK SAN. ve TİC. LTD. ŞTİ
Ümraniye/İSTANBUL

Is found to comply with

Türk Loydu's Materials Rules for Classification of Steel Ship, Türk Loydu's Rules for Classification and Construction of Yacht and ISO 12216.

Application	: Hatch to be used ships according to Türk Loydu Materials Rules, Türk Loydu's Rules for Classification and Construction of Yacht and ISO 12216.
Design	: BOFOR DENİZCİLİK SAN. ve TİC. LTD. ŞTİ
Sizes	: a) Clear open: 500x600 mm, Cut out: 588x688 mm, Overall: 648x748 (FLSHTCWT 56) b) Clear open: 600x600 mm, Cut out: 688x688 mm, Overall: 748x748 (Interior or Exterior Handle), (FLSHTCWT 60) c) Clear open: 650x650 mm, Cut out: 738x738 mm, Overall: 798x798 (FLSHCWT 65)

Address of Manufacturer : İMES SANAYİ SİTESİ C BLOK 308 SK. NO :18, YUKARI DUDULLU-ÜMRANIYE/İSTANBUL

Place and date
İSTANBUL 22.03.2010

Subject to the conditions referred to 2nd page,
this certificate is valid until 21.03.2015

R. Tansel TİMUR
Head Of Marine Division

S. Mahir TUĞCU
Surveyor

1/2



Form No: CE 191-03

Certifying products, processes and persons

DUTCH
CERTIFICATION
INSTITUTE

Member of Lloyd's Netherlands*

www.dciworldwide.eu

Certificate of EC Type-Examination



Dutch Certification Institute, Notified Body for certification of Recreational Crafts to the Directives 94/25/EC en 2003/44/EC under number 0613 and established at Joure, the Netherlands, herewith declares that the under mentioned product has been assessed according to module B+F of the Recreational Craft Directive 94/25/EC and, if applicable, 2003/44/EC and meets all applicable essential safety requirements.

*Manufacturer: Bofor Denizcilik
Imes Sanayi Sitesi C Blok 308 Sok 18
Yukari Dudullu Umraniye
Istanbul, Turkey*

Product description: Hatch HTC-27x27 up to HTC-60

Design category: Area II; A,B,C & D

The enclosed list with essential documents of the Technical Documentation forms a whole with this certificate. This certificate remains valid as long as the product is up to the assessed prototype and follows the instructions: Correct use of the certificate.

*Thus made and drawn up at Joure, the Netherlands, in good faith
and to the best of knowledge.*

*Certificate number: CE-RCD-191
Date of issue: 14-11-2005
Expire Date: 14-11-2010*

*Mr. R. van Eijl
Head of Certification department*



COPY

Certifying products, processes and persons

DUTCH
CERTIFICATION
INSTITUTE

Member of Lloyd's Netherlands®

Certificate of EC Type-Examination

www.dutchworldwide.eu



Dutch Certification Institute, Notified Body for certification of Recreational Crafts to Directives 94/25/EC and 2003/44/EC under number 0613 and established at Joure, the Netherlands, herewith declares that the under mentioned product has been assessed according to module B+C of the Recreational Craft Directive 94/25/EC and, if applicable, 2003/44/EC and meets all applicable essential safety requirements.

Manufacturer: Bofor Denizcilik
Imes Sanayi Sitesi C Blok 308 Sok 18
Yukari Dudullu Umraniye
Istanbul, Turkey

Product description: Slim portlight RND-20; OVL-20x40;
OVL-20x50; REC-17x29; REC-18x32;
REC-20x40; REC-25x50

Design category: Area III; A,B,C & D

The enclosed list with essential documents of the Technical Documentation forms a whole with this certificate. This certificate remains valid as long as the product is up to the assessed prototype and follows the instructions: Correct use of the certificate.

Thus made and drawn up at Joure, the Netherlands, in good faith and to the best of knowledge.

Certificate number: CE-RCD-192
Date of issue: 14-11-2005
Expire Date: 14-11-2010

Mr. R. van Eijl
Head of Certification department



PRODUCTEN
RVA C 208

COPY

Certificate of EC Type-Examination



Dutch Certification Institute, Notified Body for certification of Recreational Crafts to the Directive 94/25/EC and 2003/44/EC under number 0613 and established at Joure, the Netherlands, herewith declares that the under mentioned product has been assessed according to module B+F of the Recreational Craft Directive 94/25/EC and, is applicable, 2003/44/EC and meets all applicable essential safety requirements.

Manufacturer: **BOFOR**
Imes Sanayi Sitesi
C Blok 308 Sok 18
Yukari Dudullu Umraniye ISTANBUL

Product description: **Ultra slim hatch**

The enclosed list with essential documents of the Technical Documentation forms a whole with this certificate. This certificate remains valid as long as the product is up to the assessed prototype and follows the instructions: Correct use of the certificate.

Thus made and drawn up at Joure, the Netherlands, in good faith and to the best of knowledge.

Certificate number: **CE-RCD-330**
Date of issue: **06-11-07**
Date of expiry: **06-11-12**

Mr. R. van Eijl
Head of Certification department





INTERNATIONAL MARINE CERTIFICATION INSTITUTE

International Non-Profit Association

Rue Abbé Cuypers 3 / B-1040 Bruxelles / Belgique / +32 2 741 8835 / +32 2 741 2478
www.imci.org / info@imci.org

EC-TYPE EXAMINATION CERTIFICATE

We hereby certify that the product below manufactured by

Bofor Marine Products

İmce Sanayi C Blok 508. Sk. No. 18 - TR-81260 İSTANBUL/YUKARI DUDULLU, ÜMRANIYE - TURKEY

Window, Portlight, Hatch, Deadlight or Door

OPENING PORTLIGHT AREA 1

Specifications	
Long edge or diameter [mm]	500
Short edge [mm]	250
Boat type	All
Area type	I
Boat design category	B
Certificate number	HBOF007

meets the requirements of the Recreational Craft Directive 94/25/EC as amended by 2005/44/EC in accordance with ISO 12216



DR.-ING. UDO WOLFF PP.
Ulrich Heinemann (Managing Director)
for EU - Notified Body : 0609

2009-07-07

This certificate is valid for product identified as a
2009 model

References to the relevant standard(s) used are given on the Declaration of Conformity



NBN EN 45011 accredited organisation - Certificate No 228-PROD



INTERNATIONAL MARINE CERTIFICATION INSTITUTE

International Non-Profit Association

Rue Abbé Cuyppers 3 / B-1040 Bruxelles / Belgique / +32 2 741 6830 / +32 2 741 2418
www.imci.org / info@imci.org

EC-TYPE EXAMINATION CERTIFICATE

We hereby certify that the product below manufactured by

Bofor Marine Products

İmce Sanayi C'Bluk 508. Sk. No. 18 - TR-81260 İSTANBUL/YUKARI DUDULLU, ÜMRANIYE - TURKEY --

Window, Portlight, Hatch, Deadlight or Door
FIXED PORTLIGHT AREA 1

Specifications	
Long edge or diameter [mm]	500
Short edge [mm]	250
Boat type	All
Area type	I
Boat design category	A
Certificate number	HBOF006

meets the requirements of the Recreational Craft Directive 94/25/EC as amended by 2005/44/EC in accordance with ISO 12216



DR. - ING. UDO WOLFF PP.
Ulrich Heinemann (Managing Director)
for EU - Notified Body - 0609
2009-07-07
This certificate is valid for product identified as a
2009 model



References to the relevant standard(s) used are given on the Declaration of Conformity

NBN EN 45011 accredited organisation - Certificate No 228-PROD



INTERNATIONAL MARINE CERTIFICATION INSTITUTE

International Non-Profit Association

Rue Abbé Cuyppers 3 / B-1040 Bruxelles / Belgique / +32 2 741 8836 / +32 2 741 2418
www.imci.org / info@imci.org

EC-TYPE EXAMINATION CERTIFICATE

We hereby certify that the product below manufactured by

Bofor Marine Products

Imci Sanayi C.Bkk. 508. Sk. No. 18 - TR-81360 ISTANBUL YUKARI DUDULLU, ÜMRANIYE - TURKEY

Window, Portlight, Hatch, Deadlight or Door
SHIP HATCH

Specifications	
Long edge or diameter [mm]	495
Boat type	All
Area type	II
Boat design category	A
Certificate number	HBOF001

meets the requirements of the Recreational Craft Directive 94/25/EC as amended by 2007/44/EC in accordance with ISO 12216



DR.-ING. UDO WOLFF P.P.

Ulrich Heinemann (Managing Director)
for EU - Notified Body : 0609

2009-07-07

This certificate is valid for product identified as a
2009 model



References to the relevant standard(s) used are given on the Declaration of Conformity

NBN EN 45011 accredited organisation - Certificate No 228-PROD



INTERNATIONAL MARINE CERTIFICATION INSTITUTE

International Non-Profit Association

Rue Abbé Cuyper 3 / B-1040 Bruxelles / Belgique / +32 2 741 6636 / +32 2 741 2418
www.imci.org / info@imci.org

EC-TYPE EXAMINATION CERTIFICATE

We hereby certify that the product below manufactured by

Bofor Marine Products

İsmet Savaş C Blok 508 Sk. No. 18 - TR-81660 İSTANBUL/YUKARI DUDULLU, ÜMRANIYE - TURKEY

Window, Portlight, Hatch, Deadlight or Door
HINGED WEATHERTIGHT DOOR

Specifications	
Long edge or diameter [mm]	1900
Short edge [mm]	750
Boat type	All
Area type	II
Boat design category	A
Certificate number	HBOF002

meets the requirements of the Recreational Craft Directive 94/25/EC as amended by 2005/44/EC in accordance with ISO 12216



DR.-ING. UDO WOLFF PP.
Ulrich Heinemann (Managing Director)
for EU - Notified Body : 0609

2009-07-07
This certificate is valid for product identified as a
2009 model



References to the relevant standard(s) used are given on the Declaration of Conformity

NBN EN 45011 accredited organisation - Certificate No 228-PROD



INTERNATIONAL MARINE CERTIFICATION INSTITUTE
International Non-Profit Association

Rue Abbé Cuyppers 3 / B-1040 Bruxelles / Belgique / +32 2 741 6836 / +32 2 741 2418
www.imci.org / info@imci.org

EC-TYPE EXAMINATION CERTIFICATE

We hereby certify that the product below manufactured by

Bofor Marine Products

İncir Sımsarı C Blok 508, Sk. No. 18 - TR-81260 İSTANBUL/YUKARI DUDULLU, ÜMRANİYE - TURKEY

Window, Portlight, Hatch, Deadlight or Door
PANTOGRAPH WATERTIGHT DOOR

Specifications	
Long edge or diameter [mm]	1900
Short edge [mm]	750
Boat type	All
Area type	II
Boat design category	A
Certificate number	HBOF003

meets the requirements of the Recreational Craft Directive 94/25/EC as amended by 2005/44/EC in accordance with ISO 12216



DR.-ING. UDO WOLFF PP.
Ulrich Heinemann (Managing Director)
for EU - Notified Body : 0809

2009-07-07

This certificate is valid for product identified as a
2009 model



References to the relevant standard(s) used are given on the Declaration of Conformity

NBN EN 45011 accredited organisation - Certificate No 228-PROD



INTERNATIONAL MARINE CERTIFICATION INSTITUTE

International Non-Profit Association

Rue Abbé Coepens 3 / B-1040 Bruxelles / Belgique / +32 2 741 6636 / +32 2 741 2418
www.imci.org / info@imci.org

EC-TYPE EXAMINATION CERTIFICATE

We hereby certify that the product below manufactured by

Bofor Marine Products

İsmet Sinayı C. Blok 508. Sk. No. 18 - TR-81260 İSTANBUL/YUKARI DUDULLU, ÜMRANIYE - TURKEY

Window, Portlight, Hatch, Deadlight or Door

HINGED WATERTIGHT DOOR

Specifications

Long edge or diameter [mm]	1900
Short edge [mm]	750
Boat type	All
Area type	II
Boat design category	A
Certificate number	HBOF004

meets the requirements of the Recreational Craft Directive 94/25/EC as amended by 2005/44/EC in accordance with ISO 12216



DR.-ING. UDO WOLFF PP
Ulrich Heinemann (Managing Director)

for EU - Notified Body : 0609

2009-07-07

This certificate is valid for product identified as a
2009 model



References to the relevant standard(s) used are given on the Declaration of Conformity

NBN EN 45011 accredited organisation - Certificate No 228-PROD

Not:

.....

.....

.....

.....

.....

.....

.....

.....

.....

.....

.....

.....

.....

.....

.....

.....

.....

.....

.....

.....

.....

.....

.....